

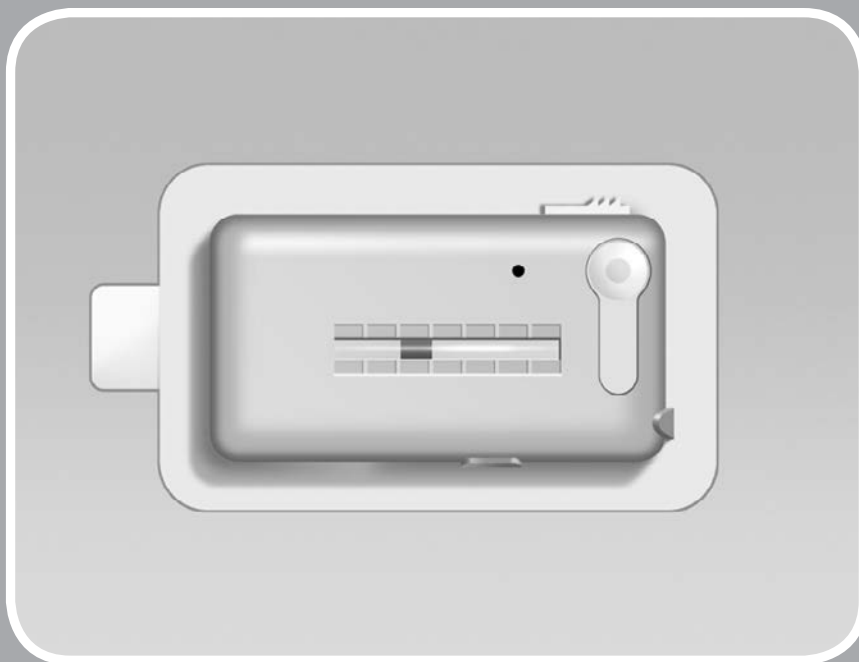

V-Go®
Customer Care
1-866-881-1209
www.go-vgo.com

Using the V-Go® Wearable Insulin Delivery Device Instructions for Patient Use



Training on the proper use of V-Go is important. If you have not been previously trained, speak to a V-Go® Customer Care Representative at 1-866-881-1209 before using V-Go.

Read the entire manual before operating the V-Go® Wearable Insulin Delivery Device.

CONTENTS	
Section 1 (Part 1): Introduction and V-Go® Overview	4
Healthcare professional prescribing considerations	4
V-Go Customer Care	6
Liability disclaimer	6
Section 1 (Part 2): Before You Begin	6
Section 2 (Part 1): V-Go Operating Instructions	7
V-Go product overview	7
EZ Fill product overview	8
Aseptic technique	9
Section 2 (Part 2): Filling the V-Go® With Insulin Using the EZ Fill	10
Step 1: Remove the plug from the EZ Fill drawer	10
Step 2: Place the V-Go into the EZ Fill	11
Step 3: Place the insulin vial into the EZ Fill insulin vial holder	12
Step 4: Fill V-Go with insulin	14
Step 5: Remove V-Go from the EZ Fill	16
Step 6: Store the EZ Fill and unfilled V-Go® devices after each day's V-Go filling session	17
Step 7: Dispose of the EZ Fill	17
Section 2 (Part 3): Applying and Using V-Go®	18
Step 1: Inspect V-Go before you attach it to your body.	18
Step 2: Wash your hands	19
Step 3: Select and prepare the infusion site.	19
Step 4: Attach V-Go	21
Step 5: Start the 24-hour flow of insulin with V-Go	23
Step 6: Bolus dose with the V-Go at mealtimes	24
Step 7: Monitor V-Go progress	26
Step 8: Remove V-Go	27
Step 9: Dispose of V-Go	29
Section 3: V-Go® Safety Information	30
Caution.	30
Indication	30
Healthcare professional dosing considerations.	31
Warnings	31
Precautions.	32
Adverse reactions	35
Section 4: Product Specifications	36
EZ Fill	36
V-Go®	37
Delivery accuracy test results	38
Section 5: V-Go® Support	40
Section 6: Troubleshooting/Frequently Asked Questions	41
Section 7: Glossary and Packaging Symbols	48

V-Go Wearable Insulin Delivery Device should be used only by people who have been prescribed the device, and only for intended use.

Terms in ***bold and italic*** are explained in the glossary.

SECTION 1 (Part 1): INTRODUCTION AND V-Go® OVERVIEW

V-Go provides a continuous **subcutaneous** insulin infusion over 24 hours. It uses a preset **basal rate** for between-meal and nighttime insulin. The V-Go provides on-demand **bolus** dosing to cover **glucose** intake at meals. The V-Go device is convenient and easy to operate (see Section 3 for indication).

Here is how to use V-Go:

- Fill V-Go with insulin using the EZ Fill
- Attach V-Go to a selected site on your body
- Push the Start Button to initiate delivery of the preset basal rate
- Wear each V-Go for one (1) 24-hour period
- Push the Bolus Ready Button followed by the Bolus Delivery Button to provide bolus doses at meals as prescribed by your healthcare professional
- At the end of the 24-hour period, retract the needle by sliding and then pushing the Needle Release Button and remove the V-Go from your body
- Discard the device after use (V-Go is 100% disposable)
- Repeat these steps for each 24-hour period using a new V-Go

Healthcare Professional Prescribing Considerations

Dosing considerations

- When selecting a V-Go option, healthcare professionals should refer to their own experience when initiating continuous subcutaneous insulin infusion therapy with a patient. If unfamiliar, the healthcare professional should refer to insulin therapy guidelines from diabetes associations and product prescribing information.
- The following should be considered when initially prescribing V-Go:
 - Understand the total daily dose of insulin your patient is *actually* taking with their current insulin regimen versus what is being prescribed. Selecting the correct V-Go option may lessen the risk of **hypoglycemia** (low blood sugar).
 - It is common practice to reduce the total daily insulin dose when *starting* a patient on continuous subcutaneous insulin infusion therapy and this reduction should be considered when starting a patient on V-Go.

Other prescribing considerations

- A separate prescription of a U100 fast-acting insulin is required for use with V-Go (see Section 3 for insulins tested with V-Go).
 - Two (2) vials of insulin are required for the V-Go 20 option.
 - Three (3) vials of insulin are required for the V-Go 30 and 40 options.

V-Go comes in 3 options for your insulin needs. Your healthcare professional has selected the most appropriate V-Go option for you.

The 3 V-Go options are:



- 20 Units/24 hr (0.83 U/hr) basal rate and up to 36 Units of on-demand bolus dosing in 2-Unit increments*. Total insulin volume is 56 Units.



- 30 Units/24 hr (1.25 U/hr) basal rate and up to 36 Units of on-demand bolus dosing in 2-Unit increments*. Total insulin volume is 66 Units.



- 40 Units/24 hr (1.67 U/hr) basal rate and up to 36 Units of on-demand bolus dosing in 2-Unit increments*. Total insulin volume is 76 Units.

*36 Units of insulin are available for on-demand bolus dosing in all V-Go options. Bolus doses are delivered in 2-Unit increments. You can only click the Bolus Delivery Button 18 times. Each click of the Bolus Delivery Button delivers 2 Units of insulin (1 click = 2 Units).

IMPORTANT: A separate prescription for insulin is required for use with V-Go. A U100 fast-acting insulin should be used to fill V-Go. (See Section 3 for insulins tested with V-Go.)

- V-Go 20 requires two (2) vials of insulin
- V-Go 30 and 40 require three (3) vials of insulin

IMPORTANT: A V-Go Wearable Insulin Delivery Device that has been properly prescribed and used will deliver your insulin needs. Wear each V-Go for a full 24-hour period, including while you sleep.

IMPORTANT: V-Go provides basal-bolus therapy. Do not use other insulin products while on V-Go therapy unless instructed by your healthcare professional.

V-Go Customer Care

If you have any questions about using V-Go® or EZ Fill, speak to a V-Go® Customer Care Representative at 1-866-881-1209.

If you have a medical emergency while using V-Go, call 911, your healthcare professional, or go directly to the emergency room.

Liability Disclaimer

Valeritas does not give medical advice about insulin therapy. Discuss all medical therapies with your healthcare professional.

SECTION 1 (Part 2): BEFORE YOU BEGIN

Step 1: Remove the EZ Fill from the packaging



- Turn the packaging over so you can read the text.
- Peel back on the lower right corner.
- Remove the EZ Fill.

Step 2: Remove V-Go from the packaging



- Turn the packaging over so you can read the text.
- Peel back on the lower left corner on one of the V-Go containers.
- Remove V-Go. Do not pull on the adhesive tab while removing the V-Go from the container.

SECTION 2 (Part 1): V-Go OPERATING INSTRUCTIONS

IMPORTANT: Do not take V-Go apart. The contents are under pressure.

IMPORTANT: Understanding the button names and locations is important for the successful use of V-Go and EZ Fill.

V-Go Product Overview

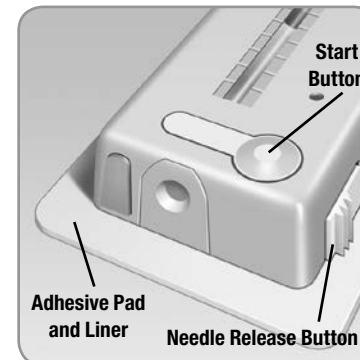
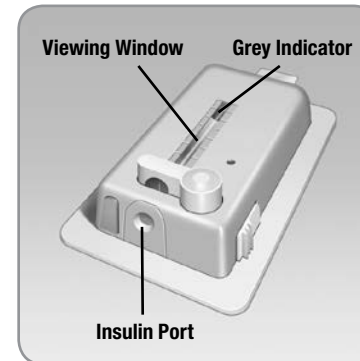
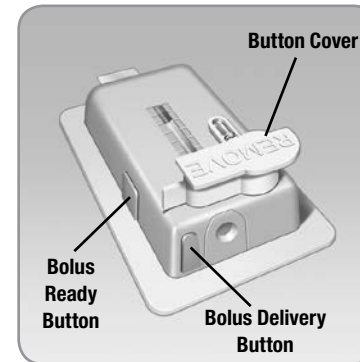

- Button Cover:** Covers the Start Button. Prevents the Start Button from being pushed in. Cover must be removed for V-Go to operate.
- Insulin Port:** Location where insulin enters the V-Go through the EZ Fill.
- Bolus Ready Button:** A grey button that lies flat on one of the long edges of V-Go. When pressed, it activates the Bolus Delivery Button. This is the first step to allow for bolus dosing of insulin.
- Bolus Delivery Button:** A grey button next to the insulin port on one of the short edges of V-Go. Pressing this button (after activated by the Bolus Ready Button) delivers a bolus dose of 2 Units of insulin (1 click = 2 Units).
- Viewing Window:** Shows the insulin reservoir. A **grey indicator** in the window demonstrates that insulin is flowing from the device.
- Start Button:** When pressed, it inserts the needle into your skin and begins the flow of insulin into your body.
- Needle Release Button:** A wide white button with 3 ridges on one of the long edges of V-Go. Sliding and pushing this button in removes the needle from your body and stops V-Go from delivering insulin.
- Adhesive Pad and Liner:** Once the protective liner is removed, the adhesive pad affixes V-Go to your skin.

EZ Fill Product Overview

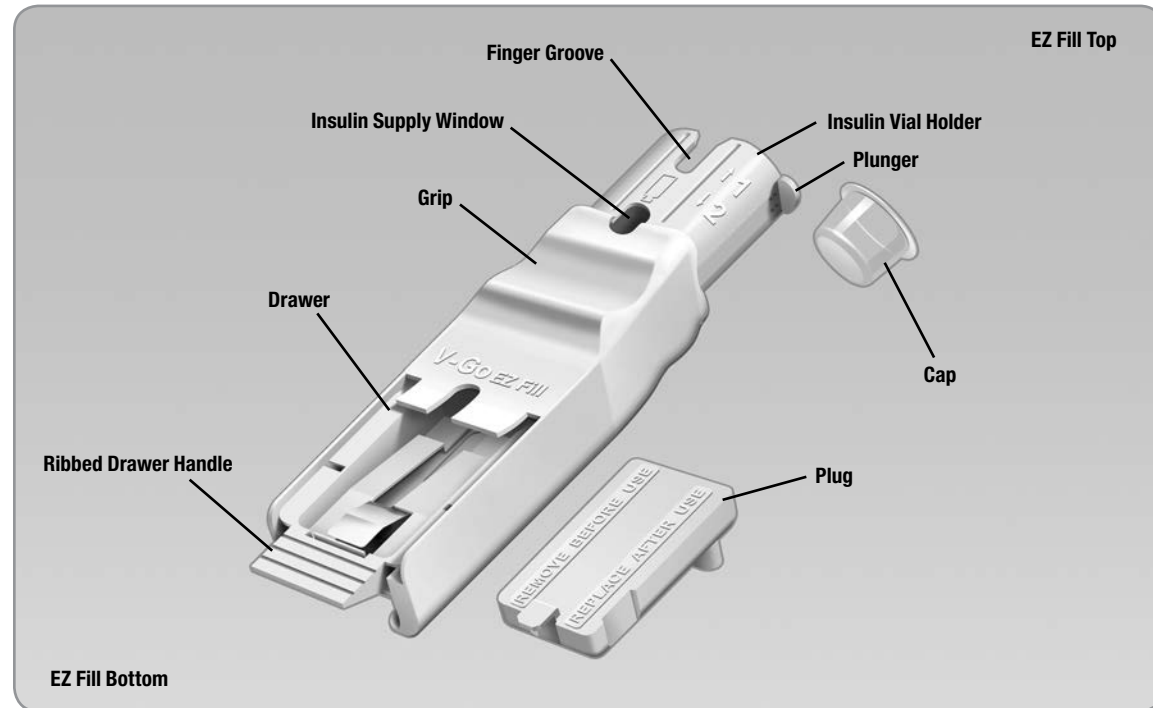

- **Cap:** Protects the needle inside the EZ Fill (bottom of insulin vial holder).
- **Finger Groove:** Opening to allow for easy removal of the insulin vial.
- **Insulin Vial Holder:** Opening in the EZ Fill where the insulin vial is placed upside down.
- **Insulin Supply Window:** Shows a view of the insulin remaining in the insulin vial.
- **Plunger:** When you pull this handle slowly up (about 5 seconds) and then push it down (about 25 seconds), insulin transfers from the vial into the V-Go®.
- **Grip:** The left thumb occupies this groove throughout most of the filling process.
- **Drawer:** V-Go is placed in this drawer for filling. The plug sits in the drawer when the EZ Fill is not in use.
- **Ribbed Drawer Handle:** A grooved piece at the bottom end of the EZ Fill that helps with opening and closing the drawer.
- **Plug:** When placed in the drawer, the plug protects the EZ Fill components between each fill.

Aseptic Technique

Aseptic technique helps keep the V-Go and the EZ Fill devices clean during preparation, filling, and application. Following this technique requires hand-washing and wiping the application site with an alcohol swab. It may involve wiping the V-Go device with an alcohol swab if the device comes into contact with anything else. Wiping the top of the insulin vial is also recommended.

Use aseptic technique when you are preparing, filling, and attaching a new V-Go.

1. Inserting a needle into your skin creates an opening where germs can enter your body. This could cause an infection at the **infusion site**. Always use aseptic technique. V-Go, EZ Fill, and other supplies come to you sterilized. To keep them that way, follow these precautions:
 - a. Always wash your hands thoroughly before preparing, filling, and attaching V-Go.
 - b. The infusion needle is sterile and protected within V-Go. Do not touch the underside of V-Go after you remove it from the sterile blister packaging. If you place V-Go on a surface, do not let the underside touch that surface. Gently lay the V-Go on the front side of the device.
2. Do not touch the circular opening on the top of the EZ Fill plug. If you place the plug on a surface, do not let the circular opening touch that surface. If the circular opening touches something, you must wipe the circular opening with an alcohol swab.
3. Wipe the infusion site of your skin with an alcohol swab. Let the alcohol dry before you attach V-Go. Do not touch this site again before putting V-Go on your skin.

SECTION 2 (Part 2): FILLING THE V-Go® WITH INSULIN USING THE EZ FILL

IMPORTANT:

Each EZ Fill is only intended to fill a 30-day supply of V-Go devices (1 V-Go per day).

A new EZ Fill will be provided with each monthly prescription of V-Go.

See V-Go specifications on page 37 for information about filling V-Go devices ahead of time. Extending beyond the times stated may result in the loss of insulin effectiveness.

Remove the EZ Fill from the refrigerator, allowing the insulin to reach room temperature (about 20 minutes) before filling V-Go.

Step 1: Remove the plug from the EZ Fill drawer

NOTE: On day 1 when you remove the EZ Fill from the packaging, the plug will be separate from the EZ Fill; therefore, you can skip Step 1.

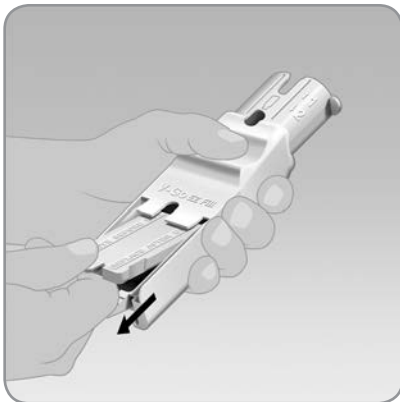

- A.** Place your thumb over the plug tab and your forefinger underneath the ribbed drawer handle. Pull the drawer out until it stops. The plug will pop up from the drawer.
- B.** Lift the plug out of the EZ Fill using your thumb and forefinger. Set the plug aside. You will replace the plug into the EZ Fill after you fill V-Go with insulin.

IMPORTANT: Do not touch the circular opening on the top of the plug. This may compromise the sterility of the EZ Fill.

Step 2: Place the V-Go into the EZ Fill

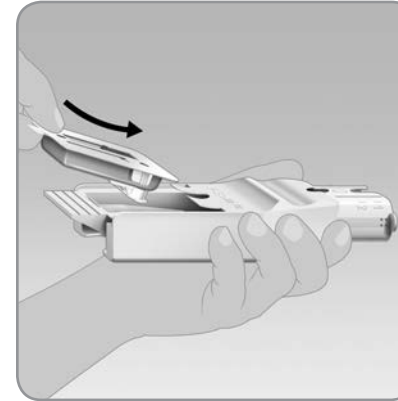

- A.** Hold the EZ Fill so that the plunger is on the top right side of the EZ Fill.
- B.** With your other hand, place V-Go into the EZ Fill drawer upside down. Place the adhesive side facing up with the plastic tab toward the bottom of the EZ Fill. The button cover should be facing down into the drawer and toward the top of the EZ Fill.

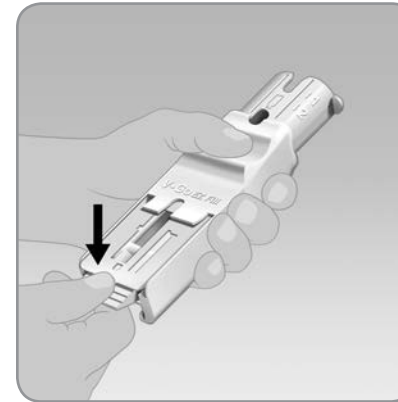

- C.** Slide the V-Go up into the EZ Fill drawer. Press V-Go flat with the top of the drawer. Hold V-Go down with your thumb.
 - Make sure that the adhesive backing on V-Go fits inside the drawer.

IMPORTANT: Make sure the V-Go lays flat when closing the drawer to prevent damaging the EZ Fill.

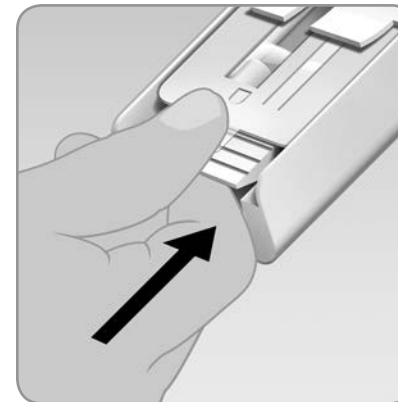

- D.** Push the drawer all the way closed until it cannot be pushed any further forward.

Step 3: Place the insulin vial into the EZ Fill insulin vial holder

NOTE: Before placing a new vial into the EZ Fill, check to make sure the insulin vial is not expired and that it will not expire during the time period that the vial will be used in the EZ Fill.

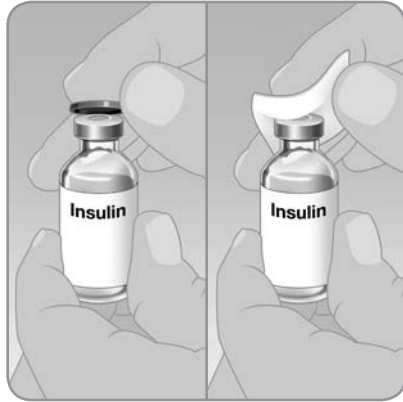

A. Remove the protective cap from the insulin vial. Wipe the top with an alcohol swab.

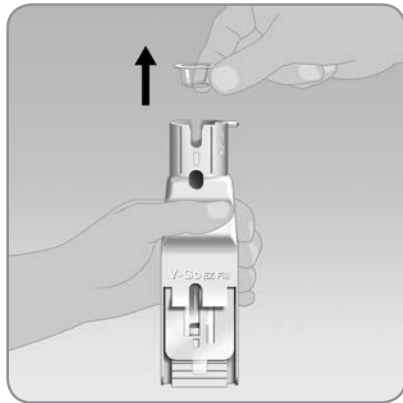

B. Pull the EZ Fill cap out of the insulin vial holder and discard.

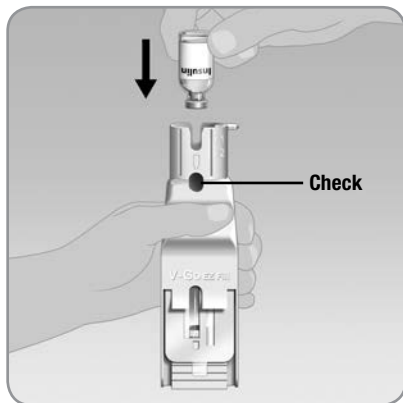

C. Turn the insulin vial upside down so the top of the vial faces downward.

D. Place the insulin vial into the EZ Fill. Push the vial firmly straight down into the insulin vial holder until you feel it attach and you cannot push it further.

E. Check the insulin supply window to make sure there is enough insulin to fill V-Go®.

Additional Steps

Remove an empty vial of insulin from the insulin vial holder and place a new vial of insulin into the insulin vial holder

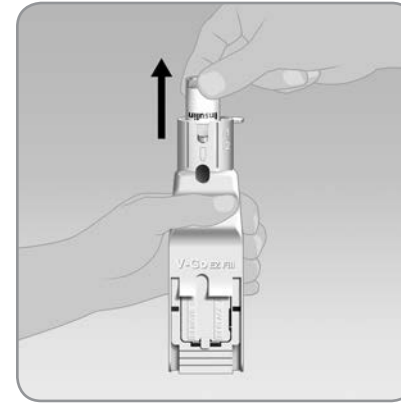

A. Grasp the vial along the finger and thumb grooves. Pull up the vial to remove it from the EZ Fill.

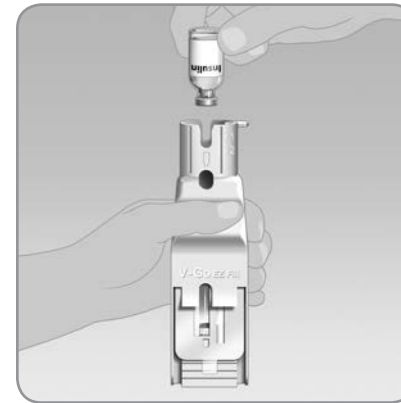

B. To place a new vial of insulin into the EZ Fill, follow filling Step 3A to 3E.

Step 4: Fill V-Go with insulin

- A.** Hold the EZ Fill upright over a counter or table by placing your thumb across the grip. The grip is just below the insulin vial holder and the plunger. Use the rest of your hand to support the back of the EZ Fill.
- Do not block light from the back of the EZ Fill. Light from the back will help you see the viewing window.

NOTE: Keep the EZ Fill in a vertical, fully upright position during filling.

Keep the viewing window at eye level. Direct the backside of the EZ Fill toward a brightly lit area when you fill V-Go. This makes it easier to see the flow of insulin. Seeing the flow of insulin helps you fill V-Go properly and completely.



- B.** Plunger should be in the down position before starting. **Slowly** pull the plunger up to its **full upright position** with your free hand and wait 5 seconds.

IMPORTANT: Make sure you slowly **pull the plunger up as far as it can go.**



- C.** Make sure the viewing window is at eye level so you can watch V-Go fill with insulin.

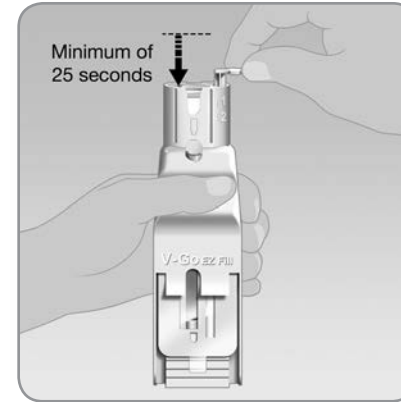

- D. Slowly and steadily** push the plunger down over a minimum of 25 seconds to fill the V-Go® with insulin.

- V-Go should be filled with insulin in a continuous flow of droplets, not in a solid, steady stream. Make sure you don't fill V-Go with a steady stream of insulin. If you push too fast or too hard the insulin will become foamy. Foamy insulin may lead to an incomplete fill. If the insulin turns foamy, push the plunger more slowly.

IMPORTANT: Watch the insulin fill V-Go to make sure you get a complete fill.

- E.** Push the plunger until it is all the way down.

- When the position of the plunger is all the way down, the V-Go should be full.

- F.** Check that V-Go is filled properly. Ideally you should see only fluid and no air space. You may see tiny air bubbles smaller than a grain of rice.

- If V-Go is not filled fully, check to see if you still have insulin in your vial.
 - If you do not, replace vial (Step 3) and repeat Step 4A to 4F.
 - If you do, repeat Step 4A to 4F.

IMPORTANT: Make sure V-Go is completely full of insulin before removing from the EZ Fill. If V-Go does not appear completely full, repeat Step 4A to 4F.

IMPORTANT: If you see air bubbles larger than a grain of rice, V-Go may not be filled completely. Repeat Step 4A to 4F in Section 2 (Part 2) to ensure a complete fill.

Having a few tiny bubbles is normal and harmless.

Step 5: Remove V-Go from the EZ Fill



- A.** Hold the EZ Fill in a sideways position.
- B.** Pull the EZ Fill ribbed drawer handle all the way out. Pull until V-Go pops up from the drawer.

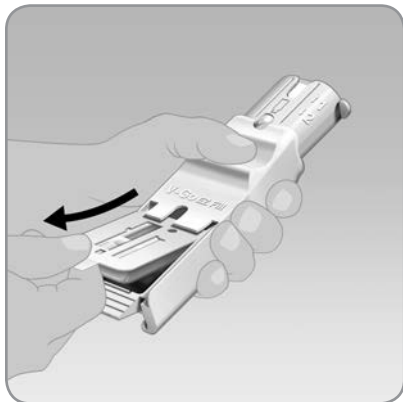

- C.** Remove the filled V-Go from the EZ Fill by lifting it up with your thumb and forefinger.
- Leave the plunger in the down position.

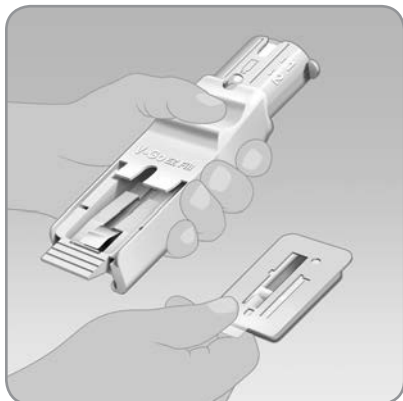

Step 6: Store the EZ Fill and unfilled V-Go® devices after each day's V-Go filling session

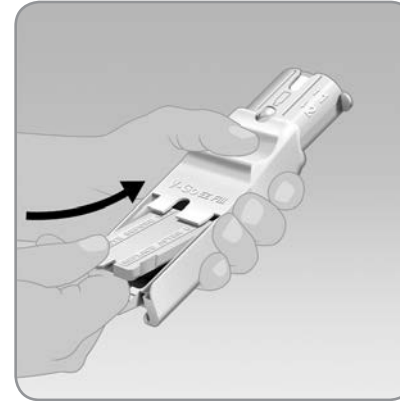

- A.** Place the plug back into the EZ Fill. Follow the directions for filling Step 2A to 2D. This time use the plug and not a V-Go.

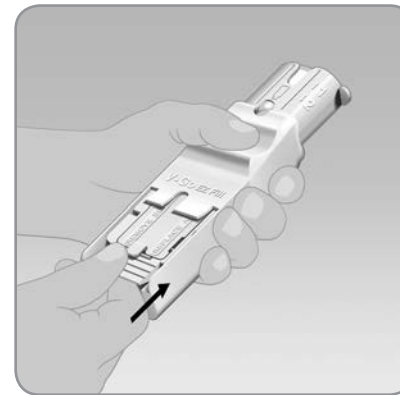

- B.** Store the EZ Fill with the insulin vial and plug attached in a clean, dry area of the refrigerator between each fill. Store unfilled, unused V-Go devices in a dry, safe place until your next fill. Please refer to Section 4 for additional storage information.

IMPORTANT: To make sure the EZ Fill remains sterile:

- Replace the plug after each fill.
- Wipe the circular opening on top of the plug with an alcohol swab before placing the plug back into the EZ Fill.

NOTE: Do not remove the insulin vial from the EZ Fill. The insulin vial should be removed only when the vial is empty.

Step 7: Dispose of the EZ Fill



- A.** After the 30-fill use period, discard the EZ Fill, with the insulin vial attached, according to local disposal requirements. The insulin vial should be discarded even if there is insulin remaining in the vial.

SECTION 2 (Part 3): APPLYING AND USING V-Go®

Step 1: Inspect V-Go before you attach it to your body



- A.** Look at the entire viewing window to make sure that V-Go has been filled completely with insulin. You should see only fluid and no air space.

- B.** Rotate V-Go and look in the viewing window. The viewing window will show you if there are any large air bubbles.
- C.** When the insulin is full in the viewing window, you are ready to attach the V-Go to your body.

IMPORTANT: To receive your total 24-hour dose of insulin, always start with a V-Go that has been completely filled with insulin.

Do not attach a partially filled or empty V-Go to your body. If V-Go is not filled completely with insulin, repeat Step 4A to 4F in Section 2 (Part 2).

Step 2: Wash your hands

Always wash your hands thoroughly before preparing V-Go for use. Use aseptic technique when you are preparing and applying a new V-Go. See the end of Section 2 (Part 1) for a description of aseptic technique.

Step 3: Select and prepare the infusion site

IMPORTANT: The place on your body where you attach V-Go is important for the success of your therapy. Choose a location that remains flat when you are sitting down, standing up, or lying down. Discuss the best location for you with your healthcare professional.

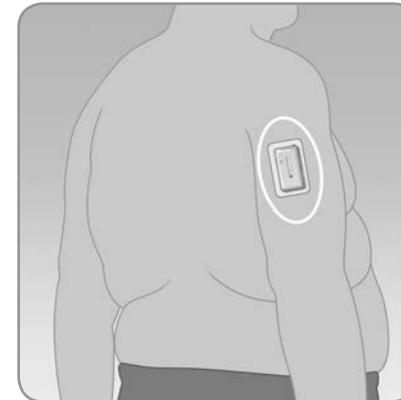
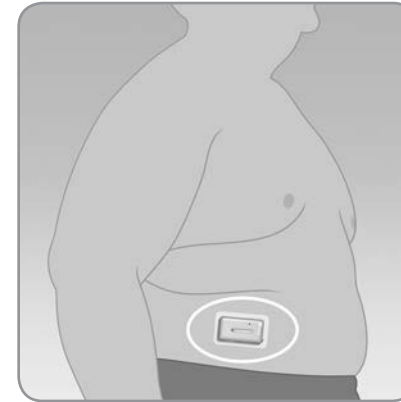

- A.** V-Go can be worn any place that insulin can be injected or infused. Insulin is injected or infused into the subcutaneous tissue.
- You may apply V-Go:
 - On the **abdomen**. The abdomen has ample flat surface area, and is an accessible and comfortable location. Insulin absorption is fast, predictable, and less affected by exercise when administered through the abdomen.
 - If V-Go is worn on the abdomen, keep it horizontal above the belt line.
 - On **backside of the arm**, not on the muscle.
 - If V-Go is worn on the backside of the arm, make sure you can see the grey indicator in the viewing window directly by rotating your arm, or indirectly through the use of a mirror.

B. When choosing the location for V-Go®, consider the following:

- Make sure you are able to view the grey indicator in the viewing window, either directly or indirectly through the use of a mirror.
- That you can comfortably reach V-Go and all of the buttons, for easy operation and removal.
- That you apply V-Go to a flat area of skin, not on a fold of the skin, muscle, or bone.
- That the site is flat when you are in any of the following positions: sitting down, standing up, or lying down.

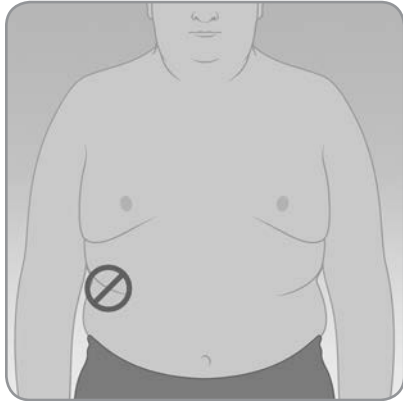

C. When choosing the location for V-Go, avoid the following:

- The belt line or waistline, or other areas where clothing may rub or constrict.
 - Areas with excessive hair. You may shave the area to help V-Go attach to your skin.
 - Areas that are curved or rigid due to muscle or bone.
 - Areas within a 1-inch circle around the belly button or surgical scars.
- Skin that is tender, bruised, red, or hard or has any skin disease or infection.

NOTE: If you have sensitive skin or your skin becomes irritated, ask your healthcare professional about skin barrier products or adhesive removers to prevent skin irritation.

NOTE: Change the location of V-Go slightly every 24 hours. Needle insertion sites should be at least 1 inch away from the last site.

This may mean moving it from the right to the left side of the abdomen. It does not require attaching V-Go on the abdomen one day then on the arm the next.

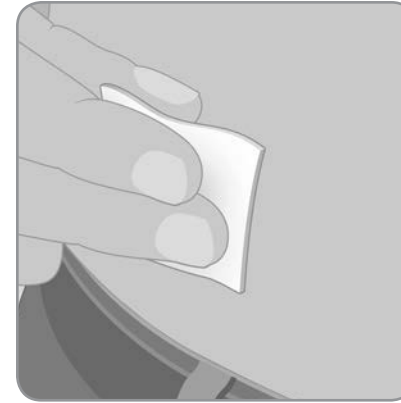

D. Clean the area where you will attach V-Go with an alcohol swab.

- The alcohol swab will remove all lotions and oils. Let the area dry. This helps the adhesive stick properly to the skin.
- Practice aseptic technique as described in Section 2 (Part 1).

Step 4: Attach V-Go

Actions in this step describe how to attach V-Go to your abdomen.

A. Practice placing V-Go before you actually remove the protective liner. Practice helps you to make sure you can reach and operate the Bolus Ready Button, Bolus Delivery Button, Start Button, and Needle Release Button.

- To practice with your right hand, hold your thumb on the Needle Release Button, your index finger near but not on the Bolus Delivery Button, and middle finger near the Bolus Ready Button.
- Hold V-Go on the selected body site to make sure that you can reach all necessary buttons when you wear V-Go.

Now you are ready to attach V-Go.

IMPORTANT: Be careful not to press any buttons when you practice attaching V-Go.

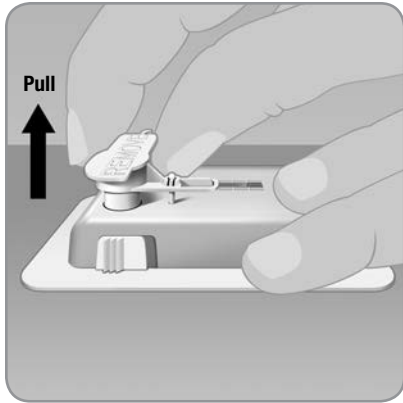

B. Remove the Button Cover.

1. Hold V-Go® with one hand and pull the Button Cover with the other hand. Pull the Button Cover in a quick, straight direction up and away from V-Go.

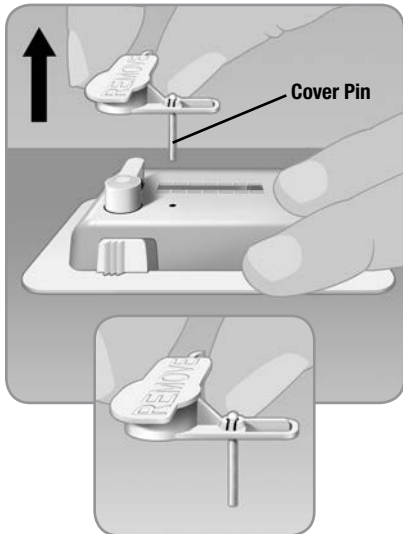

2. Check to see if the Cover Pin came off with the Button Cover.
 - If the Cover Pin is not attached and has remained inside V-Go, try to remove the pin manually; otherwise discard this V-Go and start over with a new V-Go.

IMPORTANT: If you bend the Button Cover backwards, as you would a soda pop can top, you could damage V-Go.

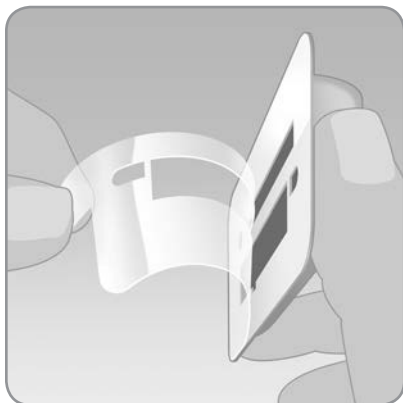

C. Lift the adhesive tab and completely peel off the adhesive liner from the bottom of V-Go. Removing the liner exposes the adhesive.

1. Do not touch the adhesive surface. Touching the adhesive surface can reduce the strength of the adhesive.
2. Keep the adhesive pad intact and clean before you place it on your body.



- D. Without touching the adhesive pad, press V-Go against the skin at the body site you cleaned for the V-Go.

- E. Hold V-Go in place for 5-10 seconds. Run your finger around the entire edge of the adhesive pad to make sure it is firmly attached to your body. Avoid accidentally pressing any of the buttons by holding the device as pictured.

Step 5: Start the 24-hour flow of insulin with V-Go

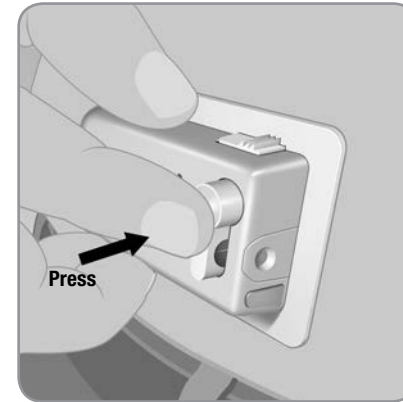

Press down on the raised bump of the Start Button with one firm quick motion. The Start Button needs to be pressed completely down into V-Go until you hear a click and the button locks in place. This begins the flow of insulin. V-Go delivers a continuous preset basal rate of insulin over 24 hours.

NOTE: Grasp the side of the V-Go as you press the raised bump of the Start Button to keep V-Go in place. Be careful not to press any other buttons during this process.

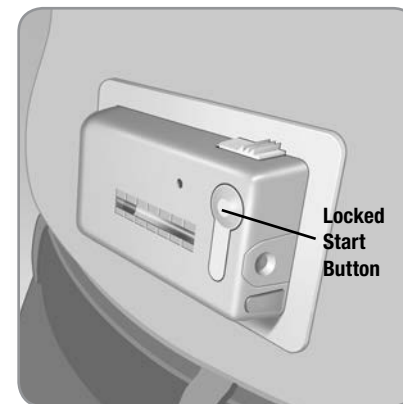

IMPORTANT: Start Button must lock in place to begin the flow of insulin.

IMPORTANT: Avoid exposing V-Go® to direct sunlight. Avoid extremely hot temperatures when wearing V-Go. Remove V-Go prior to hot tub, whirlpool, or sauna use and replace with a new filled V-Go afterward.

IMPORTANT: If the Start Button does not fully depress or does not remain in the down position, V-Go cannot function. You will not receive the preset basal rate of insulin. **Do not** use V-Go if the Start Button does not stay down. Remove and discard that V-Go. Start over with a new V-Go.

Once the Start Button is pushed down and locks into place, insulin is now flowing into your body. The needle within the V-Go remains in your body for the entire 24-hour use of V-Go. The V-Go design helps to minimize discomfort.

Step 6: Bolus dose with the V-Go at mealtimes

Your healthcare professional should have instructed you on how and when to use V-Go and how many bolus doses of insulin to administer at mealtimes and when to administer them. Consult your healthcare professional if you have questions regarding your specific bolus dosing needs.

IMPORTANT: Each V-Go has a total of 36 Units of insulin available for on-demand bolus dosing per 24-hour period. The 36 Units of insulin can only be delivered in 2-Unit increments (1 click = 2 Units). You can only click the Bolus Delivery Button 18 times in every 24-hour period. After 18 clicks, the Bolus Ready Button will lock.

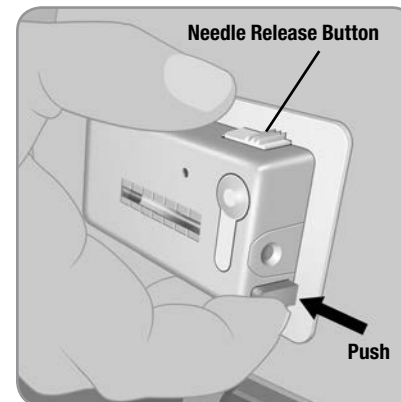
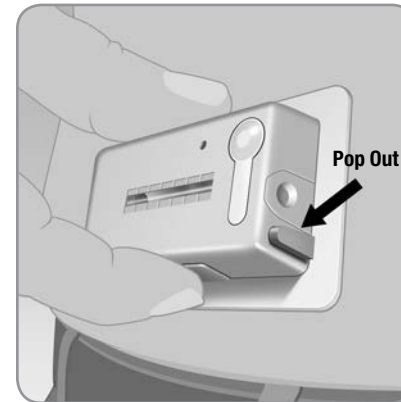
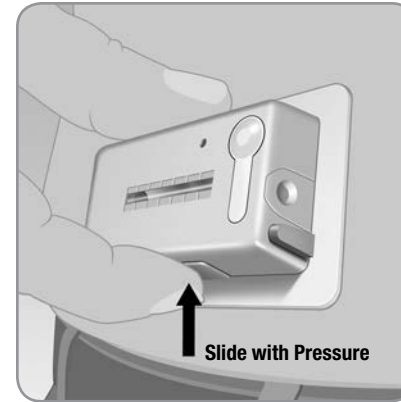

A. To administer 2 Units of insulin at mealtime:

1. Slide your finger with pressure to locate and press the Bolus Ready Button on the long edge of V-Go.

- You will hear the Bolus Delivery Button located at the end of V-Go pop out once activated.

2. Press the Bolus Delivery Button all the way into V-Go until it stops. You will hear a click.

- You have just delivered 2 Units of insulin (1 click = 2 Units).

IMPORTANT: Do not touch the Needle Release Button (button with ridges) while giving yourself bolus doses. This may cause you to retract the needle before the end of its 24-hour use and stop the delivery of insulin to your body. If this occurs and the Start Button pops out, remove V-Go and replace it with a new one.

B. Repeat Step 6A until you reach the number of bolus Units prescribed by your healthcare professional for that specified time.

NOTE: Each click of the Bolus Delivery Button delivers 2 Units of insulin (1 click = 2 Units).

IMPORTANT: If you do not know the number of insulin Units you have just delivered or if you lose count, **STOP** bolus dosing, monitor your blood glucose, and follow the plan agreed upon with your healthcare professional. If you have not agreed upon a plan already, consult your healthcare professional for guidance.

IMPORTANT: If the Bolus Ready Button or Bolus Delivery Button does not press in or does not click when pressed, you may have used all of the 18 available bolus doses.

Step 7: Monitor V-Go progress

A. While wearing V-Go, you should check your blood glucose at regular intervals to make sure V-Go is working properly as directed by your healthcare professional. Refer to Section 3 for recommendations on blood glucose monitoring.

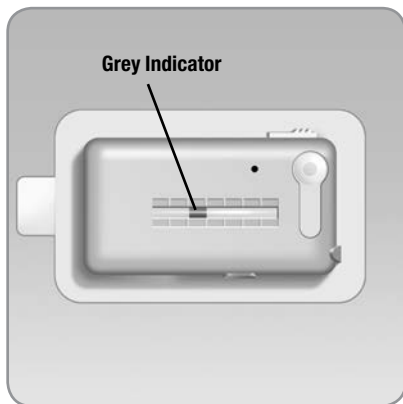

B. You can also check the movement of the grey indicator in the viewing window to make sure V-Go is working properly. After several hours, you should see a slight change in the location of the grey indicator as it moves toward the Start Button.

- The exact location of the grey indicator will vary based on the number of bolus Units you have used.

IMPORTANT: The indicator moves very slowly over the 24-hour period. It will take time to notice the change in the indicator location.

Monitoring V-Go progress is important to make sure V-Go is delivering insulin. If the indicator does not appear to be moving after several hours of wearing V-Go, consider checking your blood glucose levels. If your levels are abnormally high after normal V-Go use as prescribed by your healthcare professional, discuss with your healthcare professional.

Step 8: Remove V-Go

IMPORTANT: After 24 hours of use it is time to replace the current V-Go with a new filled V-Go.

V-Go is meant to be worn for 24 hours. Establishing a daily routine will help remind you to change V-Go every 24 hours.

NOTE: Do not block the Start Button with your finger or any part of your hand or clothing while releasing the needle via the Needle Release Button.



A. To remove the used V-Go®, place thumb on the ridged section of the Needle Release Button. Slide the Needle Release Button along the side of the V-Go. In a continuous motion, press the Needle Release Button directly into V-Go until you hear a click. This motion retracts the needle.



B. At this point the Start Button will pop out automatically.

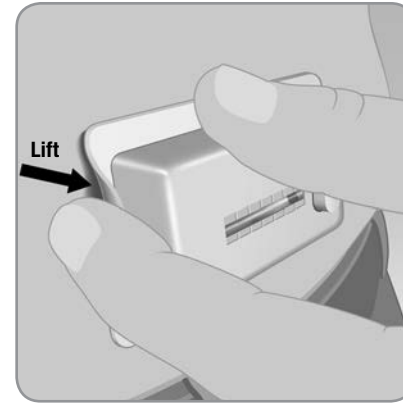
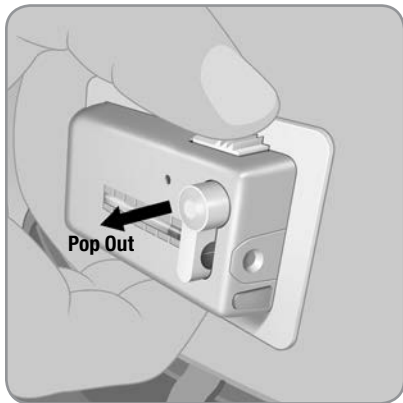

C. To remove V-Go from your skin, run a finger under an edge of the adhesive pad.

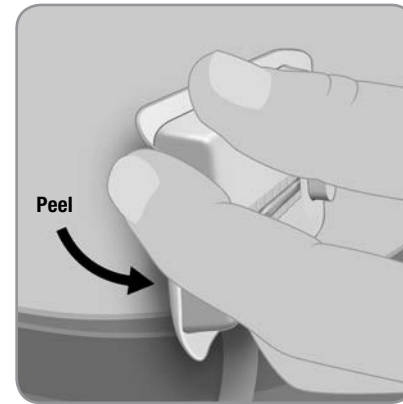

D. Press lightly on the skin adjacent to V-Go with one hand and peel V-Go away from your skin with the other hand.

NOTE: After you remove V-Go, the adhesive may leave behind a sticky residue. Use warm soapy water and roll your finger around the attachment site. This motion will remove the sticky adhesive residue.

You could use a medical adhesive remover instead. Ask your healthcare professional to recommend an adhesive remover.

Step 9: Dispose of V-Go

Discard the used V-Go according to local disposal requirements.



NOTE: When used as directed, the V-Go needle is never exposed. The needle is only in use when the device is attached to the skin and the Start Button is pressed. After use, the needle is retracted back into V-Go and locked. Once retracted, the V-Go needle is completely contained/covered.

Check to make sure the needle is retracted. If it is not, repeat Step 8A prior to disposal of V-Go.

SECTION 3: V-Go® SAFETY INFORMATION

As with many medical devices, you must be aware of safety-related issues to make sure that you are using V-Go correctly. Always consult with your healthcare professional if you have any questions regarding the functions and operation of V-Go.

Caution

Federal (United States) law restricts this device to sale by or on the order of a physician or properly licensed practitioner (prescription only).

Indication

V-Go 20:

The V-Go Wearable Insulin Delivery Device is indicated for continuous subcutaneous infusion of 20 Units of insulin in one 24-hour time period (0.83 U/hr) and on-demand bolus dosing in 2-Unit increments (up to 36 Units per one 24-hour time period) in adult patients requiring insulin.

V-Go 30:

The V-Go Wearable Insulin Delivery Device is indicated for continuous subcutaneous infusion of 30 Units of insulin in one 24-hour time period (1.25 U/hr) and on-demand bolus dosing in 2-Unit increments (up to 36 Units per one 24-hour time period) in adult patients requiring insulin.

V-Go 40:

The V-Go Wearable Insulin Delivery Device is indicated for continuous subcutaneous infusion of 40 Units of insulin in one 24-hour time period (1.67 U/hr) and on-demand bolus dosing in 2-Unit increments (up to 36 Units per one 24-hour time period) in adult patients requiring insulin.

A U100 fast-acting insulin should be used with V-Go. Humalog® (insulin lispro, rDNA origin) and NovoLog® (insulin aspart, rDNA origin) have been tested by Valeritas, Inc. and found to be safe for use in the V-Go Wearable Insulin Delivery Device.

Healthcare Professional Dosing Considerations

When selecting a V-Go basal dose option, healthcare professionals should refer to their own experience when initiating continuous subcutaneous insulin infusion therapy with a patient. If unfamiliar, the healthcare professional should refer to insulin therapy guidelines from diabetes associations and prescribing information.

The following should be considered when initially prescribing V-Go:

- Understand the total daily dose of insulin your patient is *actually* taking with their current insulin regimen versus what is being prescribed. Selecting the correct V-Go option may lessen the risk of hypoglycemia.
- It is common practice to reduce the total daily insulin dose when *starting* a patient on continuous subcutaneous insulin infusion therapy and this reduction should be considered when starting a patient on V-Go.

Warnings

Insulin requirements

If you have to make regular adjustments or modifications to your basal rate during a 24-hour period, or if the amount of insulin used at meals requires adjustments of less than 2-Unit increments, use of V-Go may result in hypoglycemia.

The following conditions may occur during insulin therapy with V-Go.

- Hypoglycemia:
 - Intensive management of diabetes with too much insulin has been associated with an increase in the incidence of hypoglycemia (low blood sugar).
- Hyperglycemia and diabetic ketoacidosis (DKA):
 - Any insulin delivery interruption may result in **hyperglycemia** (high blood sugar) or the onset of **diabetic ketoacidosis**.

If you have a medical emergency while using the V-Go, call 911, your healthcare professional, or go directly to the emergency room.

Precautions

General

The following are a number of general precautions you should consider when using V-Go® Wearable Insulin Delivery Device.

The V-Go is magnetic resonance (**MR**) unsafe.

You should remove V-Go before having an X-ray, MRI, or CT scan (or any similar test or procedure). Replace with a new V-Go after the test or procedure is completed.

You should monitor your **blood glucose levels** based on your healthcare professional's recommendation. American Diabetes Association guidelines suggest that patients test blood glucose 3 or more times daily.

You should act quickly to respond to abnormal blood sugar levels.

- Notify your healthcare professional of any serious hypoglycemia or hyperglycemia. Tell your healthcare professional of any increased frequency in abnormally high or low blood glucose test results.

You should create a plan with your healthcare professional in case a problem occurs when you are unable to reach him or her for advice.

You should create a plan with your healthcare professional on how to manage your bolus (mealtime) dosing using the V-Go, including what to do if you lose count while bolus dosing or if you forget to take a bolus dose.

You should carry an emergency kit of insulin supplies, if instructed by your healthcare professional, in case you develop a problem with V-Go that stops your insulin delivery. Tell a family member or friend where you keep your emergency kit items.

- **You should** speak with your healthcare professional regarding what to have in the emergency kit, which often includes the following items:
 - Fast-acting glucose tablets
 - Blood glucose and urine ketone monitoring supplies
 - Back-up insulin, insulin syringe, and needles with directions from your healthcare professional regarding how much insulin to take
 - Dressing and adhesive

You should avoid exposing V-Go to direct sunlight.

You should avoid exposure of the device to extremely hot temperatures. Remove V-Go prior to hot tub, whirlpool, or sauna use and replace with a new filled V-Go afterward.

You should check that V-Go is securely in place during and after periods of increased physical activity. Check that V-Go is securely in place if it has been exposed to water or gone under water to the depth of 3 feet, 3 inches (1 meter). V-Go can go under water and will continue to work safely.

You should follow these precautions to help prevent problems with the V-Go and its placement:

1. Never use insulin that appears cloudy. Cloudy insulin may be inactive. Do not use cloudy insulin with V-Go.
2. Do not expose the insulin to extreme changes in temperature. Check the insulin package insert for temperature variation.
3. Practice aseptic technique when preparing, filling, and attaching V-Go.
4. Check the adhesive site for redness, irritation, and inflammation when you remove a used V-Go and before you attach a new V-Go.
5. Change the application site each time you change V-Go. See Section 2 (Part 3) Step 3. Changing the site will ensure proper absorption of insulin. The new site should be at least 1 inch away from the previous site.
6. Do not apply V-Go to a site that has excess hair or is irritated, infected, or unhealthy for any reason. Consult with your healthcare professional about how to prepare and maintain these sites.
7. Avoid attaching V-Go to sites that may interfere with your clothing, accessories, or car seatbelts.
8. Do not attach V-Go to sites with rigorous movement and stretching due to exercise or job-related activities.

Hypoglycemia

Low blood sugar is the most common side effect associated with any insulin, including the insulin delivered using V-Go®. Symptoms of low blood sugar may vary and can happen suddenly.

To help prevent hypoglycemic episodes, follow these precautionary steps:

1. Know the symptoms of hypoglycemia. Do not ignore these symptoms, no matter how mild they may be.
2. Always carry a fast-acting sugar replacement (such as candy, juice, or glucose tablets) in the event of a hypoglycemic episode.
3. The V-Go delivery rate can vary by up to +/- 10% from device to device. Even though the chance of this happening is remote, you should monitor your glucose level at least 3 times per day or as recommended by your healthcare professional. Your healthcare professional may recommend specific times for you to check your blood glucose.
4. Check your blood glucose before driving or operating heavy machinery. Appropriate blood glucose levels are required to maintain alertness.

IMPORTANT: If your glucose level falls below 70 mg/dL, you may be having a hypoglycemic (low blood sugar) episode and you should take immediate action to raise your blood glucose level. This may be done by taking glucose tablets, eating candy, drinking juice, or doing as your healthcare professional instructs. You should retest your blood glucose after 15 minutes and if it is still below 70 mg/dL continue to take steps to increase your blood glucose level until it reaches your normal level. Consult with your healthcare professional to understand how to best recognize and manage low blood glucose.

Hyperglycemia and Diabetic Ketoacidosis (DKA)

To help prevent serious hyperglycemia (high blood sugar) and the possibility of diabetic ketoacidosis (DKA), follow these precautions:

1. Check your blood glucose frequently based on your healthcare professional's recommendation. Your healthcare professional may recommend specific times for you to check your blood glucose.

2. Be sure you know when to test for **ketones** and when your healthcare professional expects you to call with results.
3. Know your blood glucose target ranges and when your healthcare professional expects you to report trouble. When your blood glucose is high, be prepared to administer insulin. If you suspect that V-Go is not delivering insulin, refer to the Troubleshooting section of this manual on page 41.
4. Keep yourself well hydrated, especially during illness or exercise.
5. Do not treat DKA yourself. If you suspect DKA, contact your healthcare professional.

IMPORTANT: Nausea and vomiting are often the first signs of DKA. To avoid DKA, be prepared and act quickly. Don't assume your blood glucose is high because you are under stress, have the flu, or miscalculated your last meal bolus.

Adverse Reactions

Site Infection/Abscesses

Infections at the infusion site may occur. Proper site preparation and frequent site rotation (refer to Section 2 (Part 3) Step 3A to 3D) can minimize infections. Remove V-Go immediately if the area around the V-Go becomes sore, red, or swollen. Apply a new V-Go to a new, clean site away from the suspected infected area. Do not discontinue therapy without the advice of your healthcare professional.

Skin Irritation

A more common problem than infection is skin irritation. Skin may become irritated by the adhesive pad on the V-Go or by the way V-Go is positioned on your skin. Skin irritation can occur but does not lead to any further clinical complication.

NOTE: If you have sensitive skin or your skin becomes irritated, ask your healthcare professional about skin barrier or adhesive removal products.

SECTION 4: PRODUCT SPECIFICATIONS

EZ Fill

Storage Conditions — Unused Device Only	-4°F (-20°C) to +140°F (+60°C) 20% to 90% relative humidity
Operating Conditions	+40°F (+5°C) to +99°F (+37°C) 20% to 90% relative humidity Warm to room temperature to optimize fill quality
Insulin	Each time before placing a new vial into the EZ Fill, check to make sure the insulin vial is not expired and that it will not expire during the time period that the vial will be used in the EZ Fill
Duration of Use	30 fills
Disposal	Local disposal requirements

V-Go®

Basal Delivery, Continuous Subcutaneous	20 Units/24 hr (0.83 U/hr) 30 Units/24 hr (1.25 U/hr) 40 Units/24 hr (1.67 U/hr)
Bolus Delivery, On-Demand	Each click of the bolus delivery button provides 2 Units Each V-Go contains 18 clicks for a maximum of 36 Units per V-Go
V-Go Minimum Capacity Reservoir	0.56 mL V-Go 20 0.66 mL V-Go 30 0.76 mL V-Go 40
V-Go Size	2.4 x 1.3 x 0.5 inches (6.1 cm x 3.3 cm x 1.3 cm)
V-Go Weight	0.7 to 1.8 ounces (20 to 50 grams)
Storage Conditions — Device Only	+10°F (-12°C) to +140°F (+60°C) 20% to 90% relative humidity Avoid prolonged exposure to the extremes of the storage temperature range
Storage Conditions — Filled with Humalog®	V-Go may be filled with Humalog for up to 24 hours prior to use if refrigerated or if left at room temperature
Storage Conditions — Filled with NovoLog®	V-Go may be filled with NovoLog for up to 5 days prior to use if refrigerated V-Go may be filled with NovoLog for up to 3 days prior to use if left at room temperature
Operating Conditions	+40°F (+5°C) to +99°F (+37°C) 20% to 90% relative humidity Do not expose the V-Go to temperatures over 99°F for prolonged periods of time (beyond 14 hours) as this may lead to degradation of the insulin (check the insulin manufacturer's instructions for use for temperature details) and may cause the V-Go to run at a basal rate slightly greater than the specified range
Operating Atmospheric Pressure	697 hPa to 1,013 hPa (Equivalent to altitudes up to 10,000 feet [3,048 meters])
Duration of Use	24 hr
Bolus Delivery Accuracy (For all 3 V-Go options)	+/-10%
Basal Delivery Accuracy (For all 3 V-Go options)	+/-10%
V-Go Power Source	Mechanical
Enclosure Protection	Protects against the effects of submersion at depths up to 3 feet, 3 inches (1 meter) for 24 hours. (IPX8)
Needle	4.6-mm, 30-gauge needle with sharps injury prevention features and floating needle technology
Disposal	Local disposal requirements

Delivery Accuracy Test Results

The following graphs show the basal flow rate accuracy for all 3 V-Go[®] options (20/30/40) for the given time periods.

The bolus accuracy is +/-10% for all 3 V-Go options.

Flow Rate Start-up Graphs

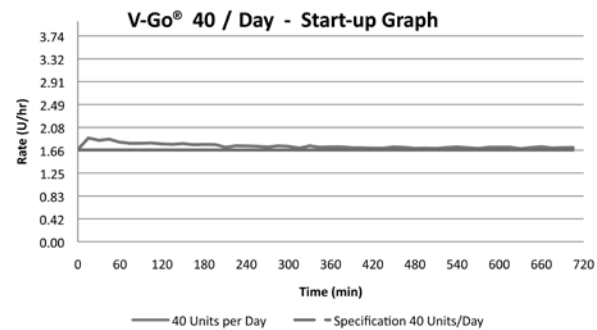
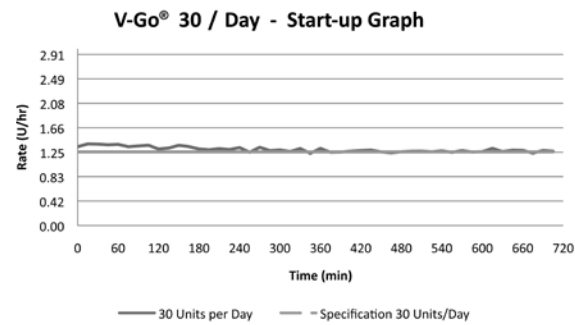
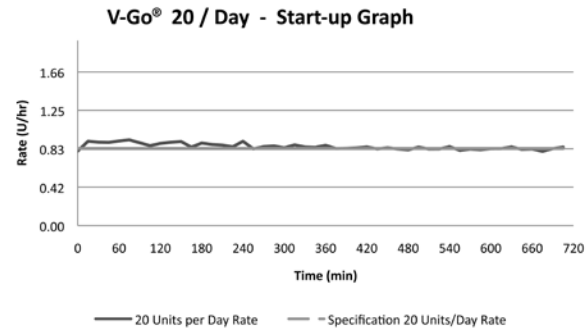

Flow Rate Start-up Graphs

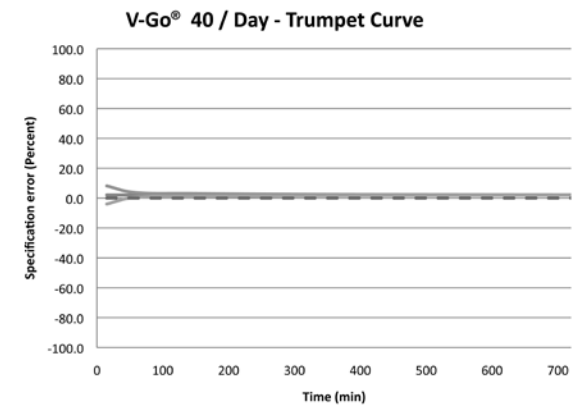
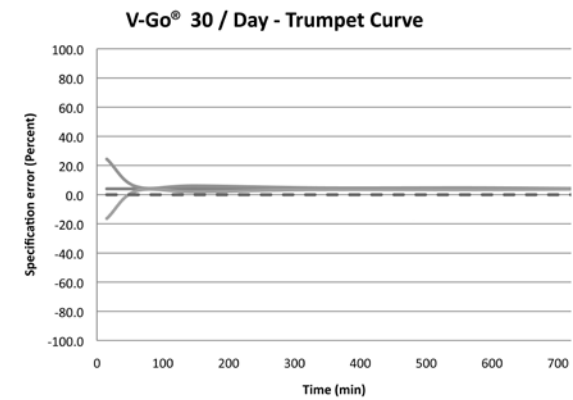
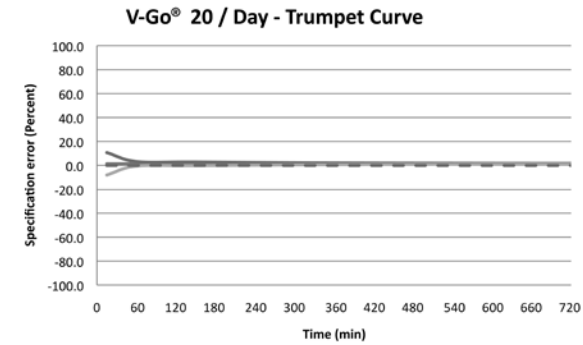

SECTION 5: V-Go® SUPPORT

V-Go® Customer Care

You may have questions or concerns when you use a new product. Please contact us for advice or assistance. A trained staff member will help you with any questions on how to fill, apply, or use V-Go.

For specific treatment questions, information on insulin, or medical advice, call your healthcare professional.

If you have any questions regarding the operation of V-Go or EZ Fill, speak to a V-Go Customer Care Representative at 1-866-881-1209.

Customers can visit the V-Go website (www.go-vgo.com) for additional information about wearable insulin delivery with V-Go.

If you have a medical emergency while using V-Go, call 911, your healthcare professional, or go directly to the emergency room.

SECTION 6: TROUBLESHOOTING/FREQUENTLY ASKED QUESTIONS

How do I know how much insulin to put into V-Go?

You always fill V-Go completely. V-Go comes in 3 options and your healthcare professional will select the option you need.

What if insulin leaks from the EZ Fill?

Check to make sure a V-Go is placed in the EZ Fill before a new insulin vial is placed into the insulin vial holder. This may reduce any insulin leakage that can happen when extra pressure is built up in the vial upon initial puncture. Also, make sure the plug is properly inserted into the EZ Fill between fills.

It looks like V-Go has not filled completely.

There are 5 reasons V-Go may not fill completely:

1. The insulin vial is not completely pushed down into the insulin vial holder.
 - If this is the case, push the vial firmly straight down into the insulin vial holder until you feel it attach and cannot push it further.
2. You have run out of insulin in your vial. You have to switch vials before you can fill the rest of V-Go.
 - If this is the case, keep V-Go in the EZ Fill drawer. Remove the insulin vial from the EZ Fill insulin vial holder, replace with a new vial, and refill V-Go.
3. You did not completely pull the plunger to its full upright position.
 - If this is the case, slowly pull the plunger up completely and repeat the filling process for V-Go.
4. You have pushed down the plunger too quickly, which turned the insulin foamy. The foam could become an air bubble larger than a grain of rice.
 - If this is the case, the EZ Fill cannot correct this error at this time. Set the V-Go aside for use on the next day and start over with a new V-Go.
 - V-Go with the foamy insulin should be stored with the insulin port up. Before using this V-Go, make sure the V-Go is fully filled. See Section 2 (Part 2) Step 4A to 4F. Refer to V-Go storage conditions in Section 4.

5. The EZ Fill drawer may not be completely closed.

- If this is the case, check again to ensure the drawer is pushed all the way closed.

In any of these situations follow Step 4A to 4F to make sure you have a complete fill.

I am looking in the viewing window while pushing the plunger down, but I don't see V-Go® filling.

There are 2 reasons you may not see any insulin fill V-Go.

1. You have run out of insulin in your vial. You have to switch vials before you can fill the rest of V-Go.

- If this is the case, keep V-Go in the EZ Fill drawer. Remove the insulin vial from the EZ Fill insulin vial holder, replace with a new vial, and refill V-Go.

2. You did not completely shut the EZ Fill drawer.

- Grip the ribbed drawer handle and push the drawer completely into the EZ Fill. The ribbed drawer handle should not stick out past the bottom of the EZ Fill.

If there is insulin in the vial and the drawer is completely shut, try to fill a new V-Go.

If you are unable to fill a new V-Go, speak to a V-Go Customer Care Representative at 1-866-881-1209.

There are bubbles in the insulin vial.

The most common reason for bubbles in the insulin vial is filling the V-Go too quickly. Make sure that you fill slowly to not create bubbles.

It is harder to push the plunger when it gets closer to the downward position.

This is normal. When V-Go is full or close to full, you should expect to push a little harder. You may need a little extra pressure to push the plunger completely down.

What happens if I do not pull the plunger completely up when I fill V-Go?

If the plunger is pulled only part of the way up during the fill process, you will get only a partial fill of V-Go. You will see air bubbles in the V-Go viewing window. Keep V-Go in the EZ Fill drawer and slowly pull the plunger up completely again. Make sure the plunger is completely up. Slowly and steadily push the plunger back down over about 25 seconds until it is in the completely down position.

I tried to pull the plunger up and it snapped back down. What should I do?

Try slowly pulling the plunger up again, but count the full 5 seconds before releasing or reversing the direction of the plunger. The plunger snaps back down if you try to pull the plunger up and release it in less than 5 seconds.

After I place V-Go into the EZ Fill drawer, what happens if the plunger is already in the up position?

You can still fill V-Go. Hold the EZ Fill upwards and slowly and steadily push the plunger down over about 25 seconds until it is in the complete down position. As you push the plunger down, check to make sure insulin enters V-Go. Repeat the plunger cycle if no insulin entered V-Go or if additional insulin is required to fill V-Go. See Section 2 (Part 2) Step 4A to 4F.

I believe an item is missing or appears to be damaged.

If you suspect an item is damaged, do not use the damaged piece. Replace this with a new one (V-Go or EZ Fill). EZ Fill replacements can be requested from a V-Go Customer Care Representative at 1-866-881-1209.

I believe I have broken the EZ Fill. How do I get another one to fill V-Go®?

EZ Fill replacements can be requested from a V-Go Customer Care Representative at 1-866-881-1209. You will be asked to return the unusable EZ Fill. V-Go Customer Care will provide you with further details.

The inner package for V-Go is torn or damaged.

If you suspect the package containing V-Go has been torn or damaged, do not use this V-Go. Replace with a new V-Go.

After I removed the button cover, the cover pin was not attached to the button cover and is still inside the V-Go.

If the cover pin is inside the V-Go, V-Go will not work correctly. Try to remove the pin manually; otherwise discard this V-Go and start over with a new V-Go.

It is difficult to press down on the Start Button.

Be sure you are pressing the raised bump of the Start Button. If the Start Button does not move when pressed, the Start Button may have already been activated. Do not use this V-Go. Replace with a new V-Go.

The Start Button will not stay in the down position.

The Start Button must be pressed down fully to be locked into place. If you cannot get the button to stay down, do not use this V-Go. Replace with a new V-Go.

V-Go won't remain securely attached to my skin for the duration of use.

If the V-Go will not remain secure, replace with a new V-Go.

When replacing V-Go, please review Section 2 (Part 3) Step 3A to 3D.

Do not touch the adhesive pad before you attach V-Go to your skin. Thoroughly clean the site with an alcohol swab. Let the site dry before attaching V-Go.

Many lotions and ointments may keep V-Go from sticking to your skin.

Be sure that you have properly attached V-Go to a flat surface on your body.

If the site is covered with hair, this could also affect whether V-Go sticks. You may shave the area to help V-Go attach to your skin.

When I went to give myself a bolus dose of insulin, the Bolus Delivery Button was already popped out.

If the Bolus Delivery Button was already popped out, the Bolus Ready Button was already activated. Press the Bolus Delivery Button to deliver 2 Units of insulin when the next bolus dose is needed.

The Bolus Delivery Button will not pop out.

First check that you are pressing the Bolus Ready Button fully. If the Bolus Delivery Button fails to pop out after you activate the Bolus Ready Button, you have used all of the available insulin for bolus dosing (36 Units or 18 clicks per 24 hours). Replace this V-Go with a new V-Go before your next meal. Plan your day so that you have enough insulin for each meal.

What should I do if I forget the number of Units I have delivered when bolus dosing or if I forget to take a bolus dose?

Follow the plan you created with your healthcare professional for such situations. If you have not created a plan already, consult your healthcare professional for guidance.

The area of skin around the V-Go is red and sore to the touch.

Skin may be irritated by the adhesive pad on the V-Go. There are a number of skin barrier products or adhesive removers available to help prevent irritation and treat sensitivity problems. Contact your healthcare professional for specific products and recommendations.

Infections at the site may also occur. If you experience redness, irritation, or inflammation around the V-Go (specifically the end closest to the needle), immediately replace V-Go with a new V-Go on a new body site. Contact your healthcare professional for the best way to treat infection and irritation, especially if the inflamed site appears bigger than a dime.

I dropped the V-Go®.

Check to see if there is any damage to V-Go. If you suspect that V-Go was damaged or became dirty as a result of the fall, do not use this one. Replace with a new V-Go.

I dropped the EZ Fill.

Check to see if there is any damage to the EZ Fill or the insulin vial, if it was attached. If the insulin vial came out of the EZ Fill, wipe the top of the vial with an alcohol swab and watch closely for leaks when you place the vial back into the EZ Fill. If insulin is leaking, replace the insulin vial with a new one. If you suspect that the EZ Fill was damaged, speak to a V-Go Customer Care Representative at 1-866-881-1209.

V-Go was exposed to water. Is this a problem?

The V-Go can go under water up to 3 feet, 3 inches (1 meter), and will continue to work safely. You should check to see that it stays in place. Depending on the cleanliness of the water, you may be at an increased risk for an infection at the needle infusion site.

Can I swim, scuba dive, shower, or bathe while wearing the V-Go?

V-Go has been successfully tested in water to depths of 3 feet, 3 inches (1 meter) for 24 hours, and therefore can be worn during normal daily activities, such as showering and bathing as well as activities near the surface of the water, such as swimming.

V-Go has not been tested and therefore should not be used in the following conditions:

- Water activities below 3 feet, 3 inches (1 meter), such as scuba diving.
- Extremely hot water temperatures, such as hot tubs or whirlpools.

Remove V-Go prior to scuba diving, hot tub use, or whirlpool use, and replace with a new filled V-Go afterward.

Can I wear V-Go for longer than 24 hours – for example, if I sleep an extra hour on the weekend?

V-Go has been designed for 24-hour wear. You should change it at the same time each day. After 24 hours, V-Go may no longer deliver a continuous preset basal rate of insulin.

How do I travel with V-Go?

Use the same precautions that you would when traveling with other insulin supplies. Speak with your healthcare professional about extra precautions you may need to take while traveling.

When traveling with the EZ Fill, with an insulin vial attached, it should be refrigerated at all times. Empty V-Go devices do not require refrigeration. They should be stored according to the storage conditions in Section 4. For information on storing filled V-Go devices refer to the V-Go storage conditions in Section 4.

Can I wear V-Go on an airplane?

Yes, V-Go can safely be worn on an airplane.

Should I wear V-Go to bed?

Yes, you should wear V-Go for a full 24 hours, even while you sleep.

The needle will not retract back into V-Go.

Try to slide and press the Needle Release Button again. See Section 2 (Part 3) Step 8A. If the needle still will not retract into the V-Go, dispose of V-Go in a sharps container.

Can I reuse my V-Go?

No, V-Go is intended for 1 use only.

Can I fill more than 1 V-Go at a time?

While it is recommended to fill V-Go daily to establish a routine, more than 1 V-Go can be filled daily according to insulin storage data provided in the specifications section on page 37. Extending beyond this may result in the loss of insulin effectiveness.

The Start Button released before the end of 24 hours. What do I do?

Replace with a new V-Go.

SECTION 7: GLOSSARY AND PACKAGING SYMBOLS

Aseptic technique: This process helps keep V-Go® and EZ Fill devices clean during preparation, filling, and application. Following this technique requires hand-washing and wiping the application site with an alcohol swab. It may involve wiping the V-Go device with an alcohol swab if the device comes into contact with anything else.

Basal rate: The basal rate is the amount of insulin delivered at a preset rate by V-Go over 24 hours. Your basal rate is the amount of insulin required to maintain your target glucose values when you are not eating. Basal rate may also be referred to as background insulin, continuous infusion, or long-acting insulin.

Blood glucose levels: Blood glucose levels are the measure of how much sugar is in the blood.

Bolus: A bolus is an amount of insulin delivered at one time. A bolus is usually taken before a meal to cover your body's insulin needs. A bolus of insulin can also be taken when blood glucose levels are abnormally high. Bolus may also be referred to as mealtime, prandial, short-acting, or rapid-acting insulin.

Diabetes mellitus: Diabetes is a disease in which the body cannot maintain its own healthy blood glucose levels. Either the body cannot produce enough insulin or the body cannot properly use insulin. There are two main types of diabetes:

- **Type 1 diabetes:** In Type 1 diabetes, the body does not produce enough insulin. People with Type 1 diabetes must use insulin to regulate their blood glucose levels.
- **Type 2 diabetes:** In Type 2 diabetes, the body does not produce enough insulin or use it properly. People with Type 2 diabetes can usually regulate their blood glucose levels by following an individual meal plan, exercising, and taking certain medicines, including insulin, if needed. It usually occurs in people 40 years or older.

Diabetic ketoacidosis (DKA): DKA occurs when the blood glucose level is elevated and the insulin level is low. The body does not have enough insulin to help the glucose enter the cells. Glucose in the cells is used for energy. During this situation, the body begins to burn muscle and fat for energy. A waste product of fat burning is ketones. Ketones accumulate in the blood and are passed through the urine and lungs. This condition can be identified by urine and/or blood tests. DKA usually requires hospitalization and can lead to a life-threatening situation if not promptly treated.

Glucose: Glucose, a sugar, is a main way the body takes in carbohydrates. Glucose is the body's most important source of energy. It is produced from digested food, by the normal action of the liver. Glucose is carried by the blood throughout the body.

Hyperglycemia: Hyperglycemia or high blood sugar occurs when blood glucose levels rise above normal levels. Hyperglycemia is the result of the body not having enough insulin or not being able to use insulin to process glucose.

Hypoglycemia: Hypoglycemia or low blood sugar occurs when blood glucose levels drop below normal levels. Hypoglycemia is the result of the body having too much insulin.

Infusion site: The infusion site is the place on the body where V-Go is attached, specifically the end of V-Go where the needle is inserted under the skin.

Insulin: Insulin is a hormone produced by the pancreas. Insulin is needed by the body to regulate the production and use of glucose.

Ketones: Ketones, or ketone bodies, are substances produced by normal liver activity, and used by muscle tissue. When blood glucose levels are elevated, the body's normal process is unbalanced and ketones can accumulate in the blood, pass through the urine, and ultimately result in diabetic ketoacidosis (DKA).

Subcutaneous: Subcutaneous means beneath the layer of the skin. The V-Go infusion needle delivers insulin subcutaneously. Subcutaneous injections are not the same thing as intravenous (IV) or intramuscular (IM) injections.

Packaging Symbols

 Rx only

 Store at

 Unless opened or damaged, contents are sterile

 Do not reuse

 Dispose of after 30 fills

 Use by

 Before using contents, read the Instructions for Patient Use

 Lot code

 MR unsafe

Humalog is a registered trademark of Eli Lilly and Company.
NovoLog is a registered trademark of Novo Nordisk A/S.



www.go-vgo.com



www.valeritas.com